

Varenummer: 0125098
 Beskrivelse: Seeger låsering SP100
 Fjederstål

Mål

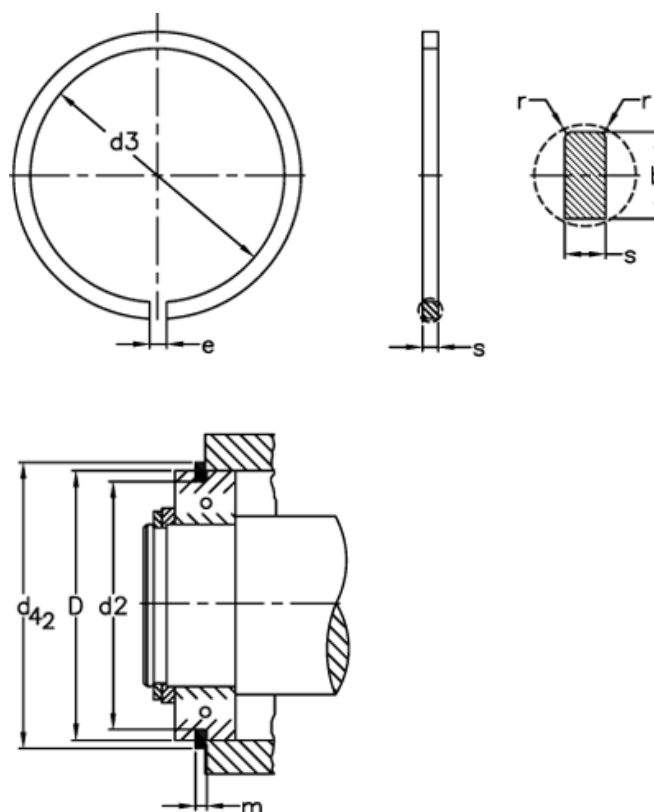

b	= 4.85	FRg kN	= 11.40	tol	= -0.15
Betegnelse	= SP 100	FR kN	= 80.8	tol	= -0.1
D	= 100	g	= 3.5	tol	= -0.50
d2	= 96.80	K kN-mm	= 155.0	tol	= 0.3
d3	= 95.2	m	= 2.70	tol	= 1.0
d42	= 106.5	n abl x 1000	= 2.0	vægt kg/1000	= 29.2
e	= 5	r min	= 0.7		
FN kN	= 82.5	s	= 2.46		